

Room thermostat Modbus

RDF400MB, RDF440MB, RDF460MB



For 2-pipe, 2-pipe with electric heater and 4-pipe fan coil units

- Communication protocol Modbus RTU server
- Slim design with touch button and frameless backlit display
- Fan output:
 - 1-speed and 3-speed fan (RDF400MB, RDF440MB)
 - DC 0...10 V fan (RDF440MB, RDF460MB)
- Control output:
 - 2-wire or 3-wire On/Off valve actuator (RDF400MB, RDF460MB)
 - 3-position valve actuator (RDF400MB, RDF460MB)
 - DC valve actuator (RDF440MB)
- 1 digital input for keycard, etc.
- Operating modes: Comfort, Economy and Protection
- Automatic or manual fan speed control
- Commissioning via local HMI or bus
- Mounting on recessed square 86 mm conduit box with 60.3 mm fixing centers
- Operating voltage:
 - AC 100...230 V (RDF400MB, RDF460MB)
 - AC/DC 24 V (RDF440MB)

Use

The thermostat is designed for use with:

- **Fan coil units** with 1-/3-speed fan controlling (RDF400MB):
 - 2-pipe system, 2-wire On/Off valve actuator
 - 2-pipe system, 3-wire On/Off valve actuator
 - 2-pipe system, 3-position valve actuator
 - 2-pipe system with electric heater, 2-wire On/Off valve actuator
 - 4-pipe system, 2-wire On/Off valve actuator
- **Fan coil units** with 1-/3-speed or DC 0...10 V fan controlling (RDF440MB):
 - 2-pipe system, DC 0...10 V valve actuator
 - 4-pipe system, DC 0...10 V valve actuator and 1-/3-speed fan only
- **Fan coil units** with DC 0...10 V fan controlling (RDF460MB):
 - 2-pipe system, 2-wire On/Off valve actuator
 - 2-pipe system, 3-wire On/Off valve actuator
 - 2-pipe system, 3-position valve actuator
 - 2-pipe system with electric heater, 2-wire On/Off valve actuator
 - 4-pipe system, 2-wire On/Off valve actuator

Functions

- | | |
|-----------------------|--|
| General functions | <ul style="list-style-type: none">● Room temperature control via built-in temperature sensor or temperature from bus● Selection of operating modes via operating mode button: Comfort or Economy● Selection of automatic or manual fan mode● Changeover between heating and cooling mode (automatic via switch for remote heating/cooling changeover or bus or manually)● Measured value adjustment of built-in temperature sensor● Key lock function● Configurable operating mode after power-up: Previous mode, Comfort or Protection● Surge protection at power-up |
| Setpoints and display | <ul style="list-style-type: none">● Min. and max. limitation of room temperature setpoint● Display of current room temperature or setpoint in °C, °F or both● Display of time of day from bus |
| Setting | <ul style="list-style-type: none">● Setting of commissioning and control parameters via:<ul style="list-style-type: none">– Local HMI– Modbus commissioning tool● Reloading factory settings● User settings and control parameters are retained in case of power failure● Password protection for parameters (disabled by default) |
| Fan | <ul style="list-style-type: none">● 1-speed, 3-speed or DC 0...10 V fan control● Configurable fan kick in Economy● Configurable fan start kick● Configurable fan operation in zero energy zone (dead zone)● Fan operating hours counter |

- Inputs
- 1 digital input D1 (for dry contact), selectable for:
 - Switch for remote heating/cooling changeover
 - Window contact to switch operating mode to Protection
 - External alarm source for status reporting via bus
 - Presence detector to switch operating mode to Comfort
 - Hotel presence detector to switch operating mode to Economy and lock the screen when the room is unoccupied
- Communication
- Communication protocol Modbus RTU server
 - Central control of setpoints and operating mode from bus
 - Monitoring of device status via bus
 - Read/write parameter via bus
 - Force change of operating mode to Protection via bus

Mechanical design

The thermostat consists of two parts:

- Control unit with user interface and I/O module
- Mounting bracket to fit onto a square conduit box with 60.3 mm fixing centers.

Operating and setting elements

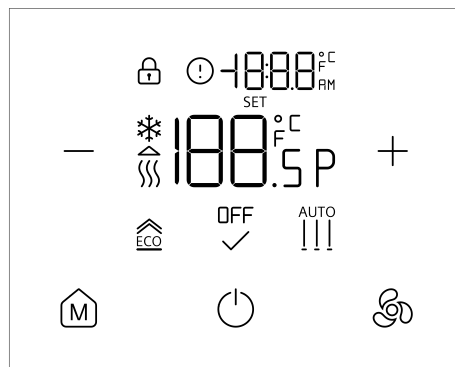

Information	Description	Information	Description
	Keylock		Alarm
	Fan mode		Economy mode
	Heating mode		Valve on
	Cooling mode	SET	Setpoint adjustment
P	Parameter setting	✓	Confirm
OFF	Protection mode		Exit
	Temperature or parameter values, etc.		Secondary display

Button	Description	Button	Description
	Switch fan mode		On / Off or confirm (✓)
	Mode selection or exit ()	+ -	Increase, decrease or select

Type summary

Product no.	Stock no.	Operating voltage	Control outputs				Fan types		Description
			On/Off	3-pos	DC 0...10 V	On/Off (3-wire)	3-speed	DC 0...10 V	
RDF400MB	S55770-T511	AC 100...230 V	✓	✓	-	✓	✓	-	Room thermostat Modbus
RDF440MB	S55770-T512	AC/DC 24 V	-	-	✓	-	✓	✓	Room thermostat Modbus
RDF460MB	S55770-T513	AC 100...230 V	✓	✓	-	✓	-	✓	Room thermostat Modbus



Ordering

When ordering, specify both product number / stock number and name: e.g. **RDF400MB / S55770-T511 Room thermostat Modbus**

Order valve actuators and external sensors separately.

Equipment combinations



On/Off actuators
(RDF400MB,
RDF460MB)





Type of units		Product no.	Data sheet ¹⁾
Electromotive On/Off valve and actuator (only available in AP, UAE, SA and IN)		MVI.../MXI...	A6V11251892
Electromotive On/Off actuator		SFA21...	N4863
Zone valve actuator (only available in AP, UAE, SA and IN)		SUA...	A6V10446174

3-position
actuators
AC 230 V
(RDF400MB,
RDF460MB)

Type of unit		Product no.	Datasheet ¹⁾
Electric actuator, 3-position (for radiator valves) AC 230 V		SSA331..	A6V11858276
Electric actuator, 3-position (for 2- and 3-port valves/V..P45) AC 230 V		SSC31	4895
Electric actuator, 3-position (for small valves 2.5 mm) AC 230 V		SSP31..	4864
Electric actuator, 3-position (for small valves 5.5 mm) AC 230 V		SSB31..	4891
Electric actuator, 3-position (for small valve 5 mm) AC 230 V		SSD31..	4861
Electric actuator, 3-position (for valves 5.5 mm) AC 230 V		SAS31..	4581

DC 0...10 V
actuators
(RDF440MB)

Type of unit		Product no.	Datasheet ¹⁾
Electric actuator, DC 0...10 V (for radiator valves)		SSA161..	A6V11858278
Electric actuator, DC 0...10 V (for 2- and 3-port valves/V..P45)		SSC161..	A6V12681511

Type of unit		Product no.	Datasheet ^{*)}
Electric actuator, DC 0...10 V (for small valves 2.5 mm)		SSF161..	A6V12681511
Electric actuator, DC 0...10 V (for small valves 5.5 mm)		SSB161..	A6V12681511
Electromotive actuator, DC 0...10 V (for valves 5.5 mm)		SAS61..	4581
Electrothermal actuator, AC 24 V, NC, DC 0...10 V, 1 m		STA161..	A6V14028280
Electrothermal actuator, AC 24 V, NO, DC 0...10 V, 1 m		STP161..	A6V14028280

^{*)} All documents can be downloaded from <http://siemens.com/bt/download>.

Product documentation



Title	Product	Document ID
Mounting instructions	<ul style="list-style-type: none"> • RDF400MB • RDF440MB • RDF460MB 	<ul style="list-style-type: none"> • A6V14125361 • A6V14125386 • A6V14125390
Basic documentation	All	A6V14153583
CE declaration	All	A5W00725830A
RCM declaration	All	A5W00727516A
UKCA declaration	All	A5W00725827A
Environmental product declaration	All	A5W00718440A

Related documents such as environmental declarations, CE declarations, etc., can also be downloaded at the following Internet address:

www.siemens.com/bt/download

Notes

Security

 CAUTION	
	<p>National safety regulations</p> <p>Failure to comply with national safety regulations may result in personal injury and property damage</p> <ul style="list-style-type: none"> • Observe any national provisions and comply with the appropriate safety regulations.

Mounting and installation

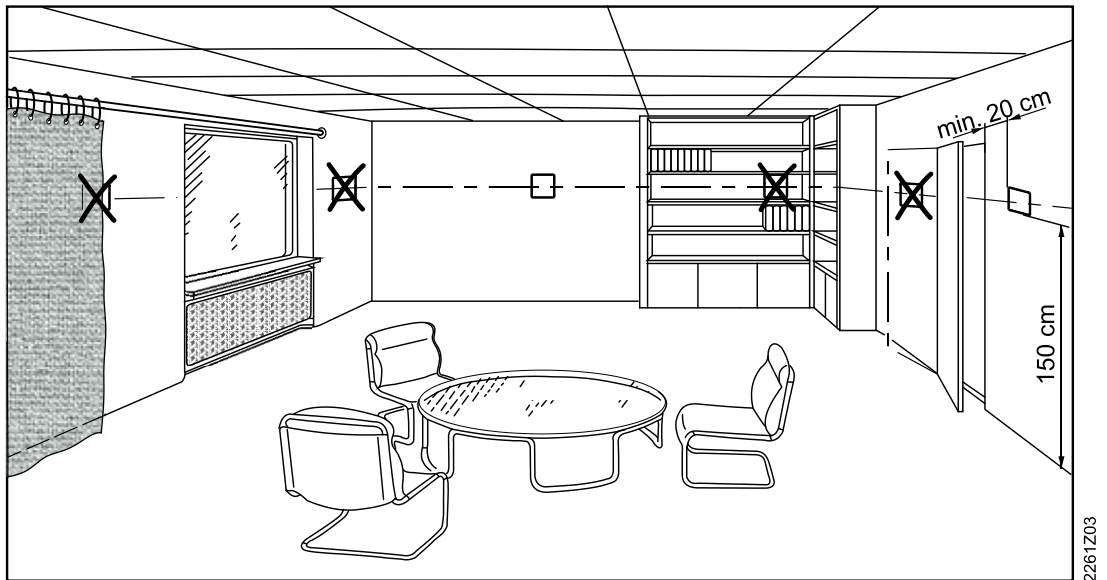

Mounting

- The device is suitable for mounting on a recessed square conduit box with 60.3 mm fixing centers.
- Recommended height: 1.5 m above the floor.
- Do not mount the devices in recesses, shelves, behind curtains or doors, or above or near heat sources.
- Avoid direct solar radiation and drafts.
- Avoid unheated (uncooled) building areas such as outside walls.
- Seal the conduit box or the installation tube if any, as air currents can affect sensor readings.
- Adhere to allowed ambient conditions.

⚠ WARNING



Device damage

Carefully read all wiring diagrams prior to installation to avoid damage to the device caused by incorrect wiring of high or low voltages.

See Mounting Instructions A6V14125361 (RDF400MB), A6V14125386 (RDF440MB) or A6V14125390 (RDF460MB) enclosed with the thermostat.

Wiring

⚠ WARNING



Wire, protect and earth in compliance with local regulations.

Risk of fire and injury due to short-circuits!

- Adapt the line diameters as per local regulations to the rated value of the installed overcurrent protection device.
- The power supply line (AC 100...230 V or AC 24 V) must have an external circuit breaker with a rated current of no more than 10 A.
- Disconnect from power before removing the device from its mounting plate.
- Isolate the cables of all SELV terminals for AC 100...230 V, e.g., Modbus communication input MB+, MB- and REF for AC 100...230 V.
- The nominal power of the electrical heater must be less than 0.8 kW, additional security element must be installed. (RDF400MB, RDF460MB)

Commissioning

After initial power-up, all LCD segments light up for about 3 seconds. Afterwards, the device enters parameter setting mode and is ready for commissioning by qualified HVAC staff. After commissioning, parameter settings mode is closed, the device restarts and is ready for normal operation.

The device control parameters can be adjusted to ensure optimum performance of the entire system (see Control parameters in [Basic documentation](#)).

Applications and settings The room thermostats are delivered with a fixed set of applications and related parameters. Select and activate the relevant application and settings during commissioning using one of the following tools:

- Local HMI
- Modbus commissioning tool

Control sequence Set the control sequence via parameter P02 depending on the application. Factory setting:

Application	Factory setting (P02)
2-pipe	2 = Cooling only
4-pipe	5 = Heating and cooling

Surge protection at power-up When the thermostats are powered, the control outputs start at random to protect the electric system against overload. It takes up to 3 seconds for all thermostat outputs to function properly.

Measured value adjustment The device has an internal sensor for accurate temperature display. If the temperature reading is affected by the installation location, adjust the sensor via parameter P13 to correct the readings.

Setpoint and range limitation For comfort and to save energy, review all setpoint related parameters and adapt them as needed.

Device address (Modbus) The device address is assigned to "1" (factory setting). Engineers/installers can change the address value using parameter P93 as needed.

Baud rate The baud rate is selectable. Four settings are available for the Modbus network: Auto, 9600 bps, 19200 bps and 38400 bps (19200 bps is default).

Modbus data frame format The Modbus data frame format can be set to 1 = 1/8/E/1, 2 = 1/8/O/1, 3 = 1/8/N/1 or 4 = 1/8/N/2 (1/8/E/1 is default).

Disposal

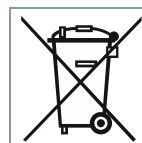

This symbol or any other national label indicate that the product, its packaging, and, where applicable, any batteries may not be disposed of as domestic waste. Delete all personal data and dispose of the item(s) at separate collection and recycling facilities in accordance with local and national legislation.
For additional details, refer to [Siemens information on disposal](#).

Cyber security disclaimer

Siemens provides a portfolio of products, solutions, systems and services that includes security functions that support the secure operation of plants, systems, machines and networks. In the field of Building Technologies, this includes building automation and control, fire safety, security management as well as physical security systems. In order to protect plants, systems, machines and networks against cyber threats, it is necessary to implement – and continuously maintain – a holistic, state-of-the-art security concept. Siemens' portfolio only forms one element of such a concept.

You are responsible for preventing unauthorized access to your plants, systems, machines and networks which should only be connected to an enterprise network or the internet if and to the extent such a connection is necessary and only when appropriate security measures (e.g. firewalls and/or network segmentation) are in place. Additionally, Siemens' guidance on appropriate security measures should be taken into account. For additional information, please contact your Siemens sales representative or visit:

<https://www.siemens.com/global/en/products/automation/topic-areas/industrial-cybersecurity.html>

Siemens' portfolio undergoes continuous development to make it more secure. Siemens strongly recommends that updates are applied as soon as they are available and that the latest versions are used. Use of versions that are no longer supported, and failure to apply the latest updates may increase your exposure to cyber threats. Siemens strongly recommends to comply with security advisories on the latest security threats, patches and other related measures, published, among others, here:

<https://www.siemens.com/cert/> => 'Siemens Security Advisories'

Warranty

Technical data on specific applications are valid only together with Siemens products listed under "Equipment combinations". Siemens rejects any and all warranties in the event that third-party products are used.

Technical data

Power supply (RDF400MB)	
Operating voltage	AC 100...230 V
Frequency	50/60 Hz
Power consumption	Max. 5 VA / 3 W
Standby power consumption	1 VA / 0.5 W
 <ul style="list-style-type: none">• No internal fuse! External preliminary protection with max. C 10 A circuit breaker in the supply line required under all circumstances.	

Power supply (RDF440MB)	
Operating voltage	AC/DC 24 V
Power consumption	Max. 5 VA / 3 W
Standby power consumption	1.2 VA / 0.5 W
External supply line protection (EU)	Circuit breaker max. 10 A Characteristic B, C, D as per EN 60898 or Power source with max. 10 A current limitation

Power supply (RDF460MB)	
Operating voltage	AC 100...230 V
Frequency	50/60 Hz
Power consumption	Max. 5 VA / 3 W
Standby power consumption	1 VA / 0.5 W
 <ul style="list-style-type: none"> • No internal fuse! <p>External preliminary protection with max. C 10 A circuit breaker in the supply line required under all circumstances.</p>	



Modbus interface	
Type	RS485
Transmit mode	RTU
Connection	Up to 32
Baud rate	Auto, 9600, 19200 (default), 38400
Device address	1...127, 1 (default)
Cable length	Max.1200 meters
Identity	Server
Transmission format (start bit – data – parity – stop)	1 = 1-8-E-1 (default) / 2 = 1-8-O-1 / 3 = 1-8-N-1 / 4 = 1-8-N-2

Wiring (RDF400MB)	
Diameter	1.0...1.5 mm ²
Power, input, and output (L, N, Q1, Q2, Q3, Y1, Y2)	
SELV signal (MB+, MB-, Ref, M, D1)	0.5...1.5 mm ²
Wire	Solid or prepared stranded wires

Wiring (RDF440MB)	
Diameter	
Power, input, and output (L1, Q1, Q2, Q3)	1.0...1.5 mm ²
SELV signal (G, G0, M, Y10, Y20, MB+, MB-, Ref, M, D1)	0.5...1.5 mm ²
Wire	Solid or prepared stranded wires

Wiring (RDF460MB)	
Diameter	
Power, input, and output (L, N, Y1, Y2)	1.0...1.5 mm ²
SELV signal (MB+, MB-, Ref, M, D1, M, Y50)	0.5...1.5 mm ²
Wire	Solid or prepared stranded wires

Output	
1-/3-speed fan (RDF400MB)	Q1...Q3
Type	On/Off
Voltage	AC 100...230 V
Maximum current	5(2) A
1-/3-speed fan (RDF440MB)	Q1...Q3
Type	On/Off
Voltage	AC 24...230 V
Maximum current	5(2) A
ECM fan (RDF440MB, RDF460MB)	RDF440MB: Y20, RDF460MB: Y50
Type	DC
Voltage	DC 0...10 V
Maximum current	±5 mA
Valve output (RDF400MB, RDF460MB)	Y1 (N.O.), Y2 (N.O.)
Voltage	AC 100...230 V
Maximum current	5(2) A
Valve output (RDF440MB)	Y10, Y20
Voltage	DC 0...10 V
Maximum current	±1 mA

 CAUTION	
	If fans must be connected in parallel, connect one fan directly, for additional fans, one relay for each speed.

Digital input	
D1-M	
Operating action	Selectable (NO/NC)
Contact sensing	DC 0...5 V, max. 5 mA
Insulation against mains power	SELV

Operating data	
Hysteresis - Heating mode (P43) - Cooling mode (P44)	0.5...6 K (factory setting: 2 K) 0.5...6 K (factory setting: 1 K)
P-band Xp - Heating mode (P43) - Cooling mode (P44)	0.5...6 K (factory setting: 2 K) 0.5...6 K (factory setting: 1 K)
Setpoint setting range - Comfort mode (P20, P21) - Economy mode (P22, P23) - Protection mode (P50, P51)	5...40 °C Off, 5...40 °C Off, 5...40 °C
Built-in room temperature sensor - Measuring range - Accuracy at 25 °C - Temperature calibration range	0...50 °C < ±0.5 K - 5.0...+5.0 K
Settings and display resolution - Temperature setpoints - Current temperature value displayed	0.5 °C 0.5 °C

Ambient conditions and protection classification	
Classification as per EN 60730 Function of automatic control devices Degree of pollution Overvoltage category Action type Rated impulse voltage Maximum altitude Software class	Type 1 2 III 1 as per EN 60730-1 4 kV as per EN 60730-1 3000 m as per EN 60730-1 A as per EN 60730-1
Classification of protection against electric shock	Device suited for use with equipment of protection class II.

Ambient conditions and protection classification	
Degree of protection of housing to EN 60529 (after mounting in position) Room automation station With terminal cover	IP30 IP30
Climatic ambient conditions - Storage as per EN 60721-3-1 Temperature range Humidity range - Transport (packaged for transport) as per EN 60721-3-2 Temperature range Humidity range - Operation as per EN 60721-3-3 ¹⁾ Temperature range Humidity range	-5...+50 °C 5...95 % r.h. -25...+70 °C 5...95 % r.h. 0...50 °C 5...95 % r.h.
Mechanical ambient conditions Storage as per EN 60721-3-1 Transport as per EN 60721-3-2 Operation as per EN 60721-3-3	Class 1M2 Class 2M2 Class 3M2

¹⁾ No condensation permitted.

Standards, directives and approvals	
Electromagnetic compatibility	For residential, commercial environments
EU conformity (CE)	A5W00725830A *)
RCM	A5W00727516A *)
UKCA	A5W00725827A *)
REACH	Regulation (EC) No 1907/2006 Registration, Evaluation, Authorization and Restriction of Chemicals (REACH)
RoHS	Directive 2011/65/EU restriction of the use of certain hazardous substances in electronic equipment
Environmental compatibility	The product environmental declaration (A5W00718440A *) contains data on environmentally compatible product design and assessments (RoHS compliance, materials composition, packaging, environmental benefit, disposal).

General	
Weight without/with package	
<ul style="list-style-type: none"> • RDF400MB • RDF440MB • RDF460MB 	<ul style="list-style-type: none"> • 163.3 g / 259.2 g • 155.2 g / 249.9 g • 152.6 g / 250.9 g
Materials	
<ul style="list-style-type: none"> • Control unit • Mounting plate 	<ul style="list-style-type: none"> • PC • PC + 10% GF
Colors	
<ul style="list-style-type: none"> • Frame • Screen 	<ul style="list-style-type: none"> • White RAL 9016 • Black RAL 9005
Housing flammability class as per UL94	V-0

*) The documents can be downloaded from <http://siemens.com/bt/download>.

Connection terminals

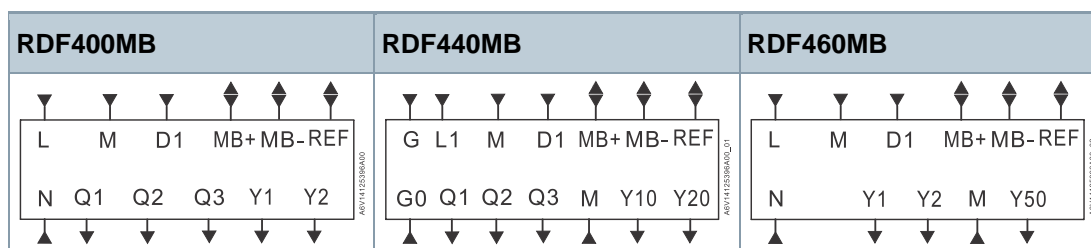

L, N	AC 100...230 V power supply, mains and neutral
G, G0	AC/DC 24 V power supply
L1	Feed for relays AC 24...230 V
Q1 **	Fan control output (relay output), Q1-low (AC 100...230 V)
Q2 **	Fan control output (relay output), Q2-middle (AC 100...230 V)
Q3 **	Fan control output (relay output), Q3 -high (AC 100...230 V)
Y1 *	SPST relay output, 2-pipe cooling/heating, or 4-pipe heating, normally open (AC 100...230 V)
Y2 *	SPST relay output, 2-pipe with electric heater, or 4-pipe cooling, normally open (AC 100...230 V)
Y10	Control outputs "valve" DC 0...10 V, 2-pipe cooling/heating, or 4-pipe heating
Y20	Control outputs "valve" DC 0...10 V, 4-pipe cooling, and 2-pipe DC fan
Y50	Control output "Fan" DC 0...10 V
M	Input reference ground for D1 or DC fan reference
D1	Digital input, e.g., switch
MB+, MB- ***	Modbus terminals
REF	Modbus reference ground

* 3-wire valve and 3-position valve actuators can also be used for 2-pipe application with Y1 and Y2 connected and P04 configured.

** For RDF440MB, the relay voltage for Qx is AC 24...230 V.

*** Isolated for RDF440MB

Connection diagrams

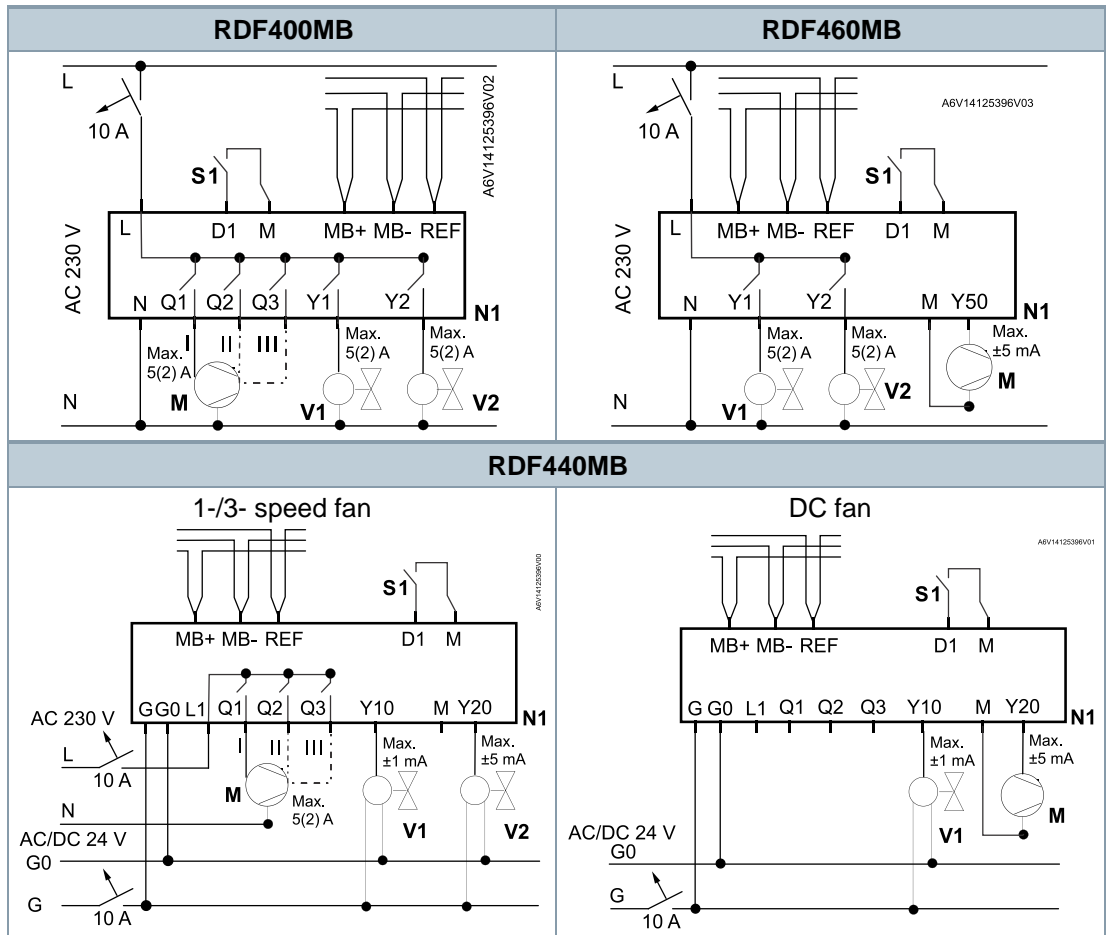

N1	RDF400MB/RDF440MB/RDF460MB
L, N	AC 100...230 V power supply, mains and neutral
G, G0	AC/DC 24 V power supply
L1	Feed for relays AC 24...230 V
Q1, Q2, Q3 **	Fan control output (relay output), Q1-low, Q2-middle, Q3-high (AC 100...230 V)
Y1 *	SPST relay output, 2-pipe cooling/heating, or 4-pipe heating, normally open (AC 100...230 V)
Y2 *	SPST relay output, 2-pipe with electric heater, or 4-pipe cooling, normally open (AC 100...230 V)
Y10	Control outputs "valve" DC 0...10 V, 2-pipe cooling/heating, or 4-pipe heating
Y20	Control outputs "valve" DC 0...10 V, 4-pipe cooling, and 2-pipe DC fan
Y50	Control output "Fan" DC 0...10 V
M	Input reference ground for D1 or DC fan reference
D1	Digital input, e.g., switch
MB+, MB- ***	Modbus terminals
REF	Modbus reference ground

* 3-wire valve and 3-position valve actuators can also be used for 2-pipe application with Y1 and Y2 connected and P04 configured.

** For RDF440MB, the relay voltage for Qx is AC 24...230 V.

*** Isolated for RDF440MB

Application and diagram	
2-pipe fan coil unit	4-pipe fan coil unit
2-pipe fan coil unit with electric heater	

YH Heating valve actuator	YHC Heating/cooling valve actuator
M1 1-speed or 3-speed fan	YC Cooling valve actuator
YE Electric heater	B2 Changeover sensor (optional)

Dimensions (mm)

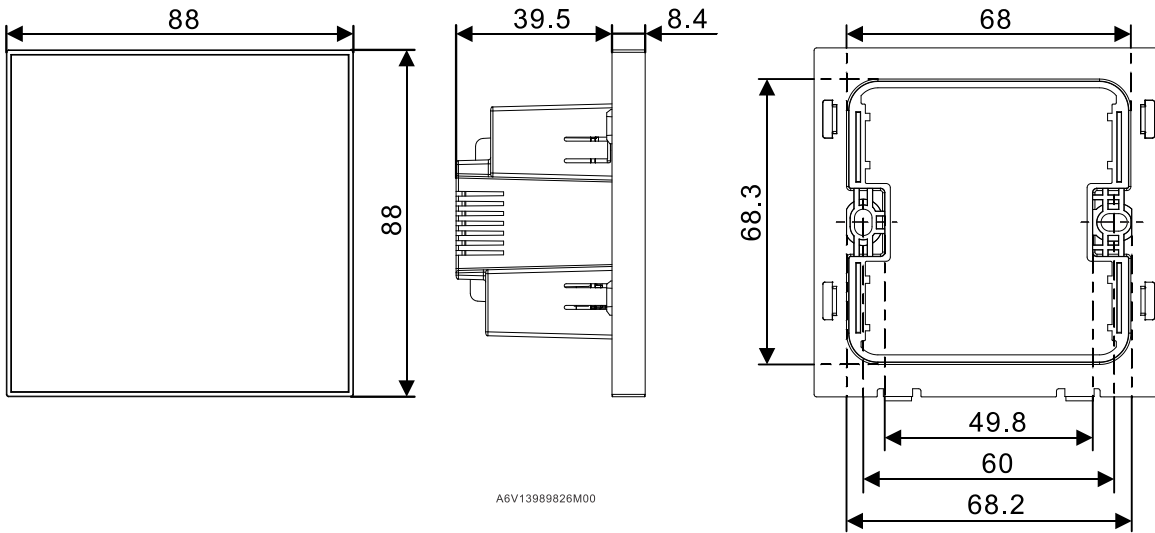

A6V13989826M00

Issued by
Siemens Switzerland Ltd
Smart Infrastructure
Global Headquarters
Theilerstrasse 1a
CH-6300 Zug
+41 58 724 2424
www.siemens.com/buildingtechnologies

© Siemens 2023
Technical specifications and availability subject to change without notice.

Document ID A6V14125396_en--_b
Edition 2024-04-16